

Home Depot Presentation



Kerdi Board Building Elements

With the available panel thicknesses of 3/16", 3/8", 1/2", 5/8", 3/4", 1", 1-1/2", and 2"



Schluter®-KERDI-BOARD

Waterproof building panel

Item No.	Width	Length	Thickness
Panel dimension: 48" x 32" – 122 cm x 81 cm			
KB 12 1220 812	48" – 122 cm	32" – 81 cm	1/2" – 12.5 mm
Panel dimension: 48" x 64" – 122 cm x 162.5 cm			
KB 5 1220 1625	48" – 122 cm	64" – 162.5 cm	3/16" – 5 mm
KB 9 1220 1625	48" – 122 cm	64" – 162.5 cm	3/8" – 9 mm
KB 12 1220 1625	48" – 122 cm	64" – 162.5 cm	1/2" – 12.5 mm
Panel dimension: 48" x 96" – 122 cm x 244 cm			
KB 5 1220 2440	48" – 122 cm	96" – 244 cm	3/16" – 5 mm
KB 9 1220 2440	48" – 122 cm	96" – 244 cm	3/8" – 9 mm
KB 12 1220 2440	48" – 122 cm	96" – 244 cm	1/2" – 12.5 mm
KB 15 1220 2440	48" – 122 cm	96" – 244 cm	5/8" – 15 mm
Panel dimension: 24-1/2" x 96" – 62.5 cm x 244 cm			
KB 19 625 2440	24-1/2" – 62.5 cm	96" – 244 cm	3/4" – 19 mm
KB 25 625 2440	24-1/2" – 62.5 cm	96" – 244 cm	1" – 25 mm
KB 38 625 2440	24-1/2" – 62.5 cm	96" – 244 cm	1-1/2" – 38 mm
KB 50 625 2440	24-1/2" – 62.5 cm	96" – 244 cm	2" – 50 mm
Panel dimension: 48" x 120" – 122 cm x 305 cm			
KB 15 1220 3050	48" – 122 cm	120" – 305 cm	5/8" – 15 mm



Schluter®-KERDI-BOARD-ZA

Profiles

U-shaped profile for finishing partition walls and shelves

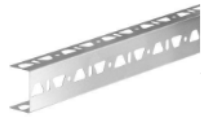

Schluter®-KERDI-BOARD-ZB

Profiles

U-shaped profile for reinforcement of KERDI-BOARD structures to be tiled



Schluter®-KERDI-BOARD-ZC

Profiles

U-shaped profile with finished facing KERDI-BOARD structures



Schluter®-KERDI-BOARD-ZW

Profiles

Angle profile used to stabilize KERDI-BOARD structures

KERDI-BOARD-U



KERDI-BOARD-E



KERDI-BOARD-V

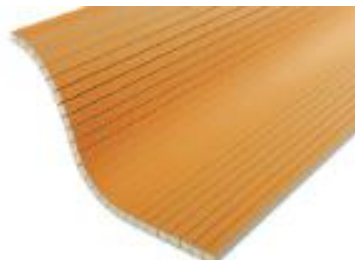

Schluter®-KERDI-BOARD-ZT

Item No.	Description	Size	Packaging
KB ZT 32 Z	Galvanized steel attachment washers	1-1/4" – 32 mm	100 washers/box
KB ZT 32 Z/L	Galvanized steel attachment washers	1-1/4" – 32 mm	1000 washers/box

Schluter®-KERDI-BOARD-ZS

Item No.	Description	Size	Packaging
KB ZS 35 G	Course thread screw for wood framing	1-5/8" – 41 mm	200 screws/box
KB ZS 55 G	Course thread screw for wood framing	2" – 50 mm	100 screws/box
KB ZS 75 G	Course thread screw for wood framing	3" – 75 mm	100 screws/box

Schluter®-KERDI-BOARD-ZT/-ZS

Item No.	Description	Size	Packaging
KBZS35GT32Z	Washer and screw set	1-5/8" – 41 mm	40 each/box



Benches, Curbs and Ramps



KERDI-BOARD-SC

Item No.	Length	Width	Height
KBSC 115 150 970	97 cm - 38"	11.5 cm - 4-1/2"	15 cm - 6"
KBSC 115 150 1220	122 cm - 48"	11.5 cm - 4-1/2"	15 cm - 6"
KBSC 115 150 1524	152 cm - 60"	11.5 cm - 4-1/2"	15 cm - 6"

KERDI-SHOWER-R

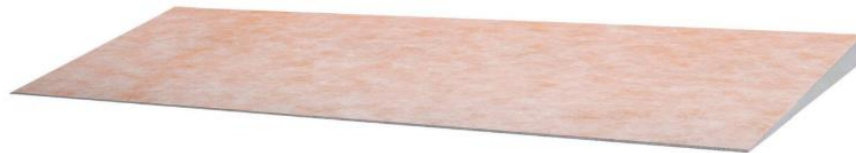

Item No.	Width	Length	Height
KSR305/1220	48" - 122 cm	12" - 30.5 cm	1-1/4" - 3.2 cm

KERDI-BOARD-SB

Item No.	Width	Length	Height	Shape
KBSB 410 TA	16" - 41 cm	16" - 41 cm	20" - 51 cm	Triangular
KBSB 610 TA	24" - 61 cm	24" - 61 cm	20" - 51 cm	Triangular
KBSB 290 970 RA	38" - 97 cm	11-1/2" - 29 cm	20" - 51 cm	Rectangular
KBSB 410 1220 RA	48" - 122 cm	16" - 41 cm	20" - 51 cm	Rectangular



Kerdi Membrane

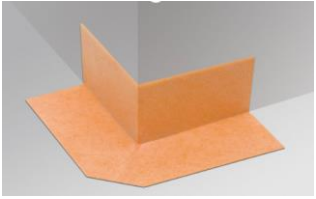

8.1 Schluter®-KERDI Waterproofing membrane

Item No.	Length	Area	Thickness
Roll width: 1 m - 3' 3"			
KERDI 200/5M	16' 5" - 5 m	54 ft ² - 5 m ²	8 mil
KERDI 200/7M	23' - 7 m	75 ft ² - 7 m ²	8 mil
KERDI 200/10M	33' - 10 m	108 ft ² - 10 m ²	8 mil
KERDI 200/20M	65' 7" - 20 m	215 ft ² - 20 m ²	8 mil
KERDI 200	98' 5" - 30 m	323 ft ² - 30 m ²	8 mil
Roll width: 2 m - 6' 7"			
KERDI 200200/15M	49' 2-1/2" - 15 m	323 ft ² - 30 m ²	8 mil
KERDI 200200	98' 5" - 30 m	646 ft ² - 60 m ²	8 mil

8.1 Schluter®-KERDI-DS Waterproofing membrane

Item No.	Width	Length	Area	Thickness
KERDI-DS	3' 3" - 1 m	98' 5" - 30 m	323 ft ² - 30 m ²	20 mil

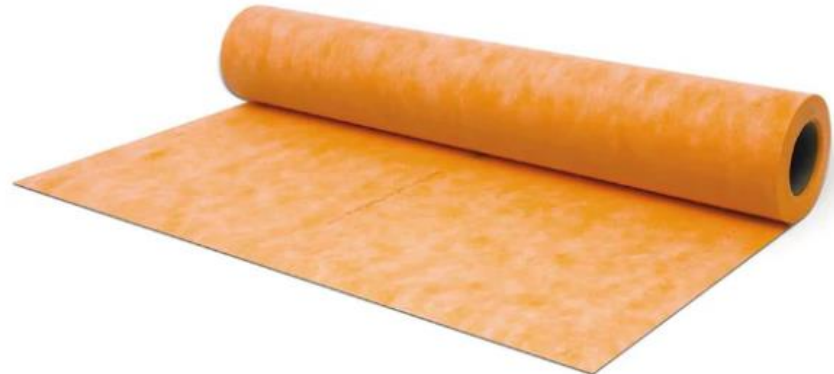

Kerdi Line & Vario Shower Trays

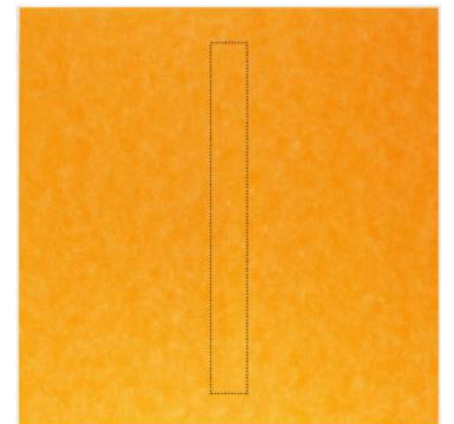
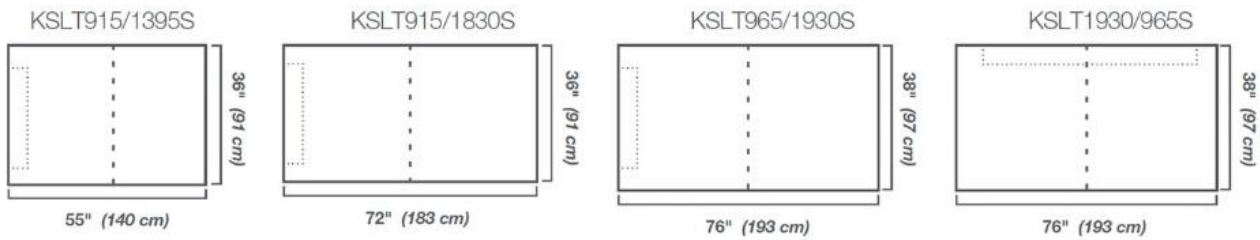
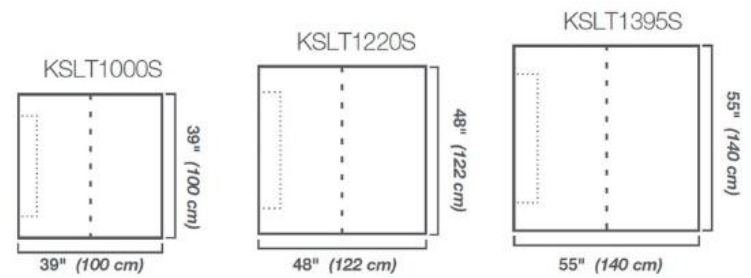
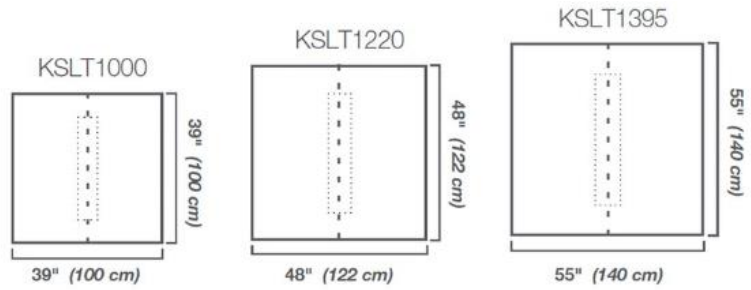

Kerdi Line

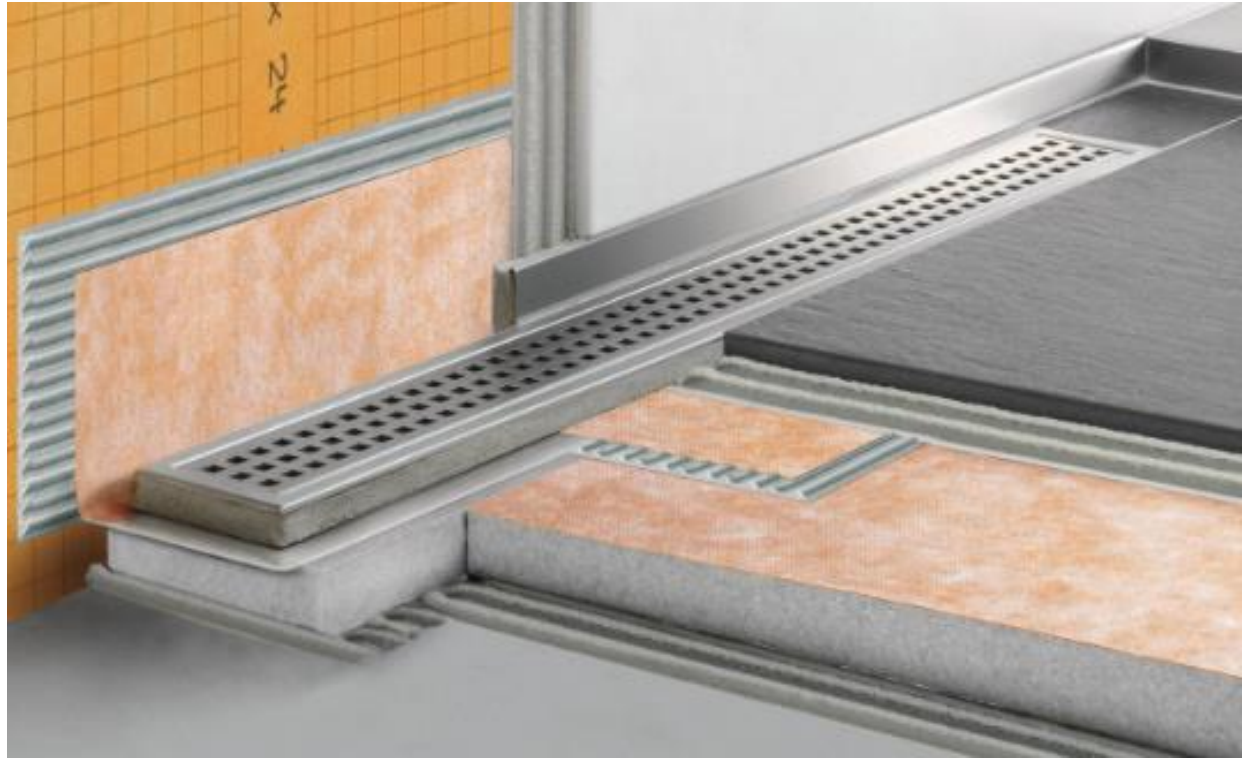

Schluter®-KERDI-LINE

Channel body - stainless steel - center outlet

L = in. - cm	L ₁ = in. - cm	Item No.
19-11/16 - 50	21-11/16 - 55	KL1V 60 E 50
23-5/8 - 60	25-5/8 - 65	KL1V 60 E 60
27-9/16 - 70	29-9/16 - 75	KL1V 60 E 70
31-1/2 - 80	33-1/2 - 85	KL1V 60 E 80
35-7/16 - 90	37-7/16 - 95	KL1V 60 E 90
39-3/8 - 100	41-3/8 - 105	KL1V 60 E 100
43-5/16 - 110	45-5/16 - 115	KL1V 60 E 110
47-1/4 - 120	49-1/4 - 125	KL1V 60 E 120
51-3/16 - 130	53-3/16 - 135	KL1V 60 E 130
55-1/8 - 140	57-1/8 - 145	KL1V 60 E 140
59-1/16 - 150	61-1/16 - 155	KL1V 60 E 150
62-15/16 - 160	64-15/16 - 165	KL1V 60 E 160
66-7/8 - 170	68-7/8 - 175	KL1V 60 E 170
70-13/16 - 180	72-13/16 - 185	KL1V 60 E 180

Channel body - stainless steel - off-set outlet

L = in. - cm	L ₁ = in. - cm	Item No.
27-9/16 - 70	29-9/16 - 75	KL1VO 60 E 70
31-1/2 - 80	33-1/2 - 85	KL1VO 60 E 80
35-7/16 - 90	37-7/16 - 95	KL1VO 60 E 90
39-3/8 - 100	41-3/8 - 105	KL1VO 60 E 100
43-5/16 - 110	45-5/16 - 115	KL1VO 60 E 110
47-1/4 - 120	49-1/4 - 125	KL1VO 60 E 120

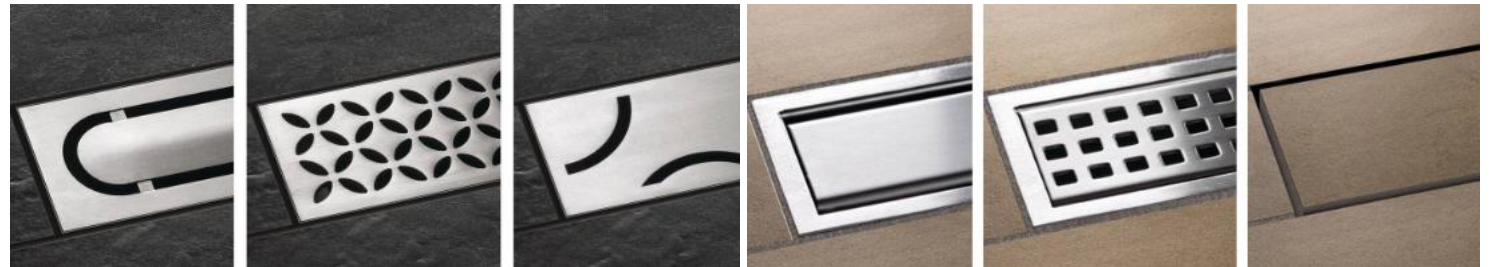

Color Codes

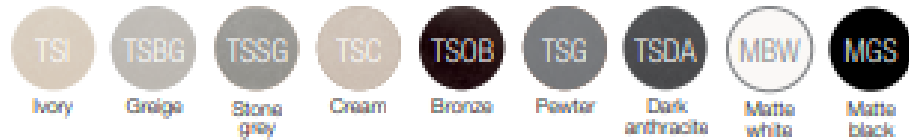

Kerdi Line Vario

FLANGE KIT

Contents

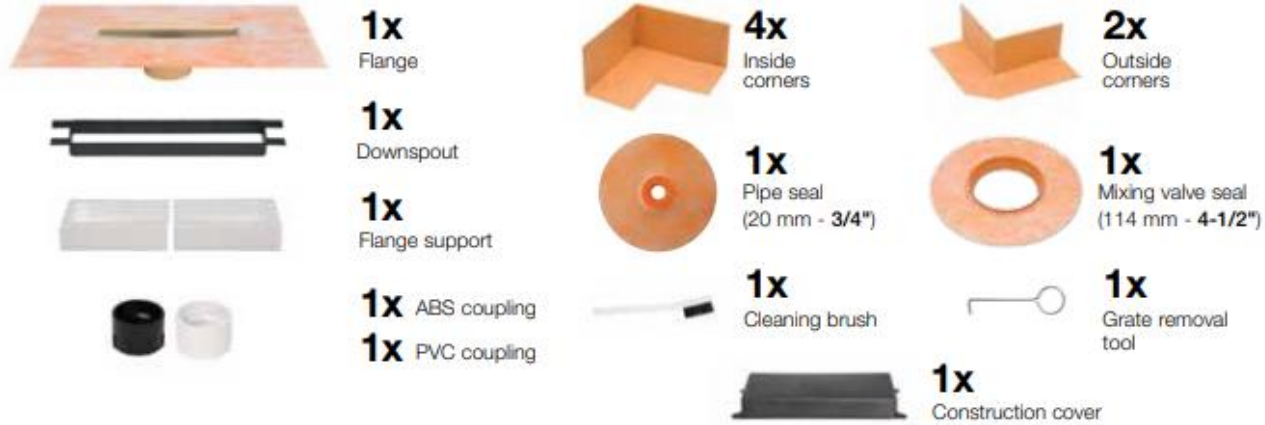

Grate and Channel Kit – Brushed stainless steel

Length = cm - in.	HERRINGBONE	SLANT	FLORAL	SQUARE
	Item No.	Item No.	Item No.	Item No.
122 - 48	KL VRI D13 EB 122	KL VRI D14 EB 122	KL VRI D5 EB 122	KL VRI D3 EB 122
244 - 96	KL VRI D13 EB 244	KL VRI D14 EB 244	KL VRI D5 EB 244	KL VRI D3 EB 244



HERRINGBONE



SLANT



SQUARE



FLORAL

*Color Codes

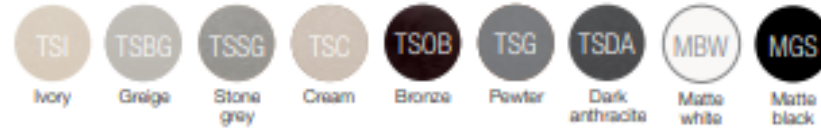

* To complete the item number, add the color code (e.g., KL VRI D3 TSI 122).

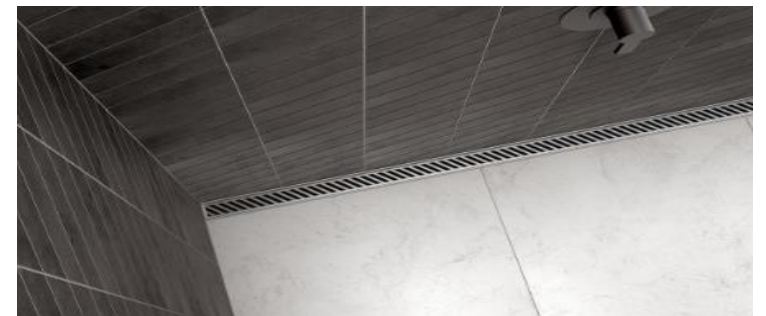

Kerdi Drain Shower Trays

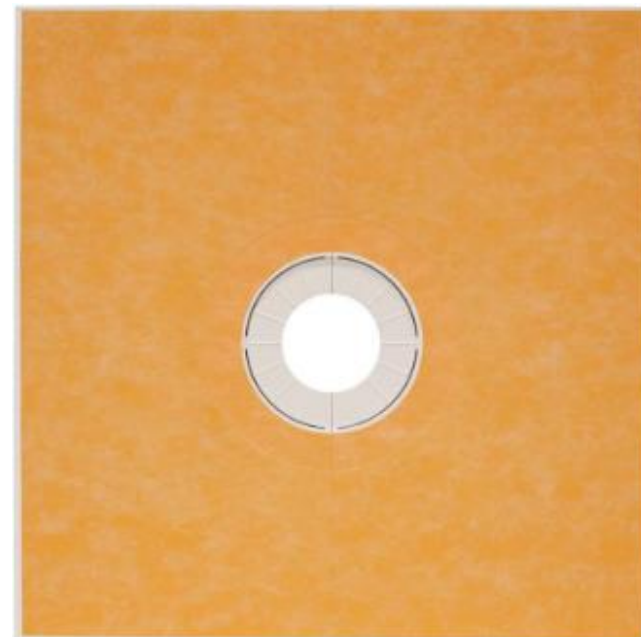
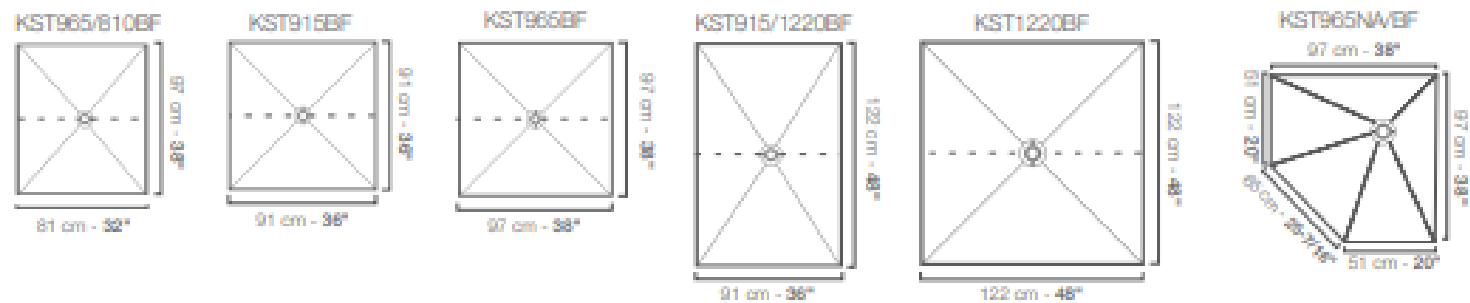
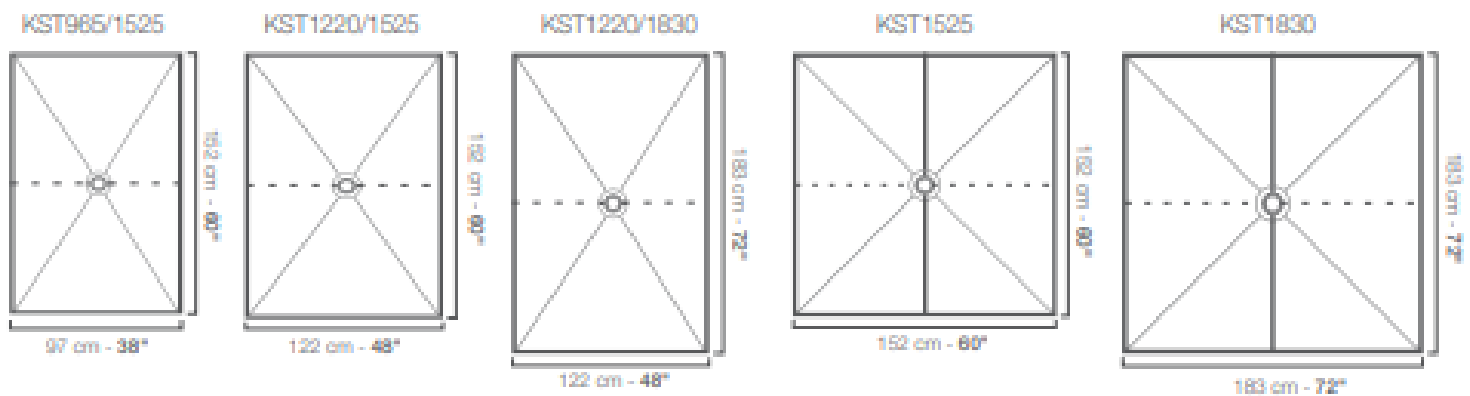







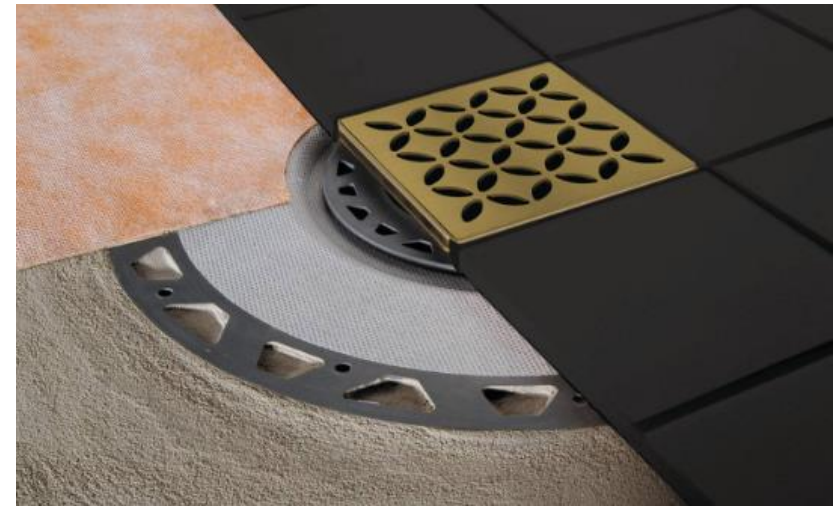

Kerdi Drain



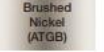

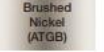

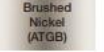



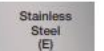
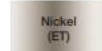



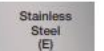
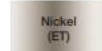





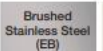
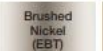



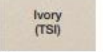

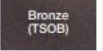
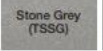
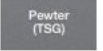

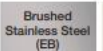
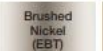



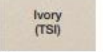

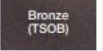
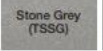
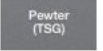

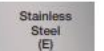
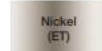



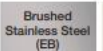
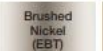



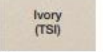

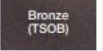
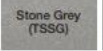
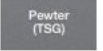



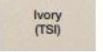

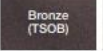
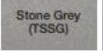
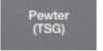

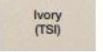

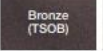
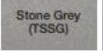
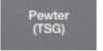
Flange Options			
ABS - 2" or 3" Outlet	PVC - 2" or 3" Outlet	Stainless Steel - 2" or 3" No-hub Outlet	Stainless Steel - 2" Threaded Outlet
			

Contents		
 1x Grate and frame	 1x Height adjustment collar	 1x Lateral adjustment ring

Contents	
 1x Tileable covering support	 1x Spacer
 1x Lateral adjustment ring	

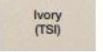

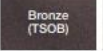
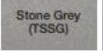
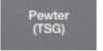
4" Grate Options				
Tileable Covering Support	Anodized Aluminum			
 TILE (ECS) Patent pending	 CONTOUR Available in the following colors and finishes: <table border="1" style="display: inline-table; margin-top: 5px;"> <tr> <td> Brushed Nickel (ATGB)</td> <td> Brushed Copper (AKGB)</td> <td> Brushed Brass (AMGB)</td> </tr> </table>	 Brushed Nickel (ATGB)	 Brushed Copper (AKGB)	 Brushed Brass (AMGB)
 Brushed Nickel (ATGB)	 Brushed Copper (AKGB)	 Brushed Brass (AMGB)		

Stainless Steel																			
 CLASSIC Available in the following colors and finishes: <table border="1" style="display: inline-table; margin-top: 5px;"> <tr> <td> Stainless Steel (E)</td> <td> Nickel (ET)</td> </tr> <tr> <td> Chrome (EP)</td> <td> Vintage Gold (EVG)</td> </tr> <tr> <td> Oil-rubbed Bronze (EOB)</td> <td> Classic Gold (ECG)</td> </tr> </table>	 Stainless Steel (E)	 Nickel (ET)	 Chrome (EP)	 Vintage Gold (EVG)	 Oil-rubbed Bronze (EOB)	 Classic Gold (ECG)	 PURE Available in the following colors and finishes: <table border="1" style="display: inline-table; margin-top: 5px;"> <tr> <td> Brushed Stainless Steel (EB)</td> <td> Brushed Nickel (EBT)</td> <td> Brushed Vintage Gold (EBVG)</td> <td> Brushed Classic Gold (EBCG)</td> </tr> <tr> <td> Matte White (MBW)</td> <td> Ivory (TSI)</td> <td> Greige (TSBG)</td> <td> Cream (TSC)</td> </tr> <tr> <td> Bronze (TSDB)</td> <td> Stone Grey (TSSG)</td> <td> Pewter (TSG)</td> <td> Dark Anthracite (TSDA)</td> </tr> </table>	 Brushed Stainless Steel (EB)	 Brushed Nickel (EBT)	 Brushed Vintage Gold (EBVG)	 Brushed Classic Gold (EBCG)	 Matte White (MBW)	 Ivory (TSI)	 Greige (TSBG)	 Cream (TSC)	 Bronze (TSDB)	 Stone Grey (TSSG)	 Pewter (TSG)	 Dark Anthracite (TSDA)
 Stainless Steel (E)	 Nickel (ET)																		
 Chrome (EP)	 Vintage Gold (EVG)																		
 Oil-rubbed Bronze (EOB)	 Classic Gold (ECG)																		
 Brushed Stainless Steel (EB)	 Brushed Nickel (EBT)	 Brushed Vintage Gold (EBVG)	 Brushed Classic Gold (EBCG)																
 Matte White (MBW)	 Ivory (TSI)	 Greige (TSBG)	 Cream (TSC)																
 Bronze (TSDB)	 Stone Grey (TSSG)	 Pewter (TSG)	 Dark Anthracite (TSDA)																
 CURVE Available in the following colors and finishes: <table border="1" style="display: inline-table; margin-top: 5px;"> <tr> <td> Matte White (MBW)</td> <td> Ivory (TSI)</td> <td> Greige (TSBG)</td> <td> Cream (TSC)</td> </tr> <tr> <td> Bronze (TSDB)</td> <td> Stone Grey (TSSG)</td> <td> Pewter (TSG)</td> <td> Dark Anthracite (TSDA)</td> </tr> </table>	 Matte White (MBW)	 Ivory (TSI)	 Greige (TSBG)	 Cream (TSC)	 Bronze (TSDB)	 Stone Grey (TSSG)	 Pewter (TSG)	 Dark Anthracite (TSDA)	 FLORAL Available in the following colors and finishes: <table border="1" style="display: inline-table; margin-top: 5px;"> <tr> <td> Matte Black (MGS)</td> </tr> </table>	 Matte Black (MGS)									
 Matte White (MBW)	 Ivory (TSI)	 Greige (TSBG)	 Cream (TSC)																
 Bronze (TSDB)	 Stone Grey (TSSG)	 Pewter (TSG)	 Dark Anthracite (TSDA)																
 Matte Black (MGS)																			



Kerdi Drain A



Schluter®-KERDI-DRAIN-A

Drains / Adaptor Drains
Adaptor kits convert
clamping ring drains to an
integrated bonding flange



Schluter®-KERDI-LINE-A

Drains / Adaptor Drains
Adaptor kit converts
clamping ring drains to an
integrated bonding flange
for linear drain



Kerdi Drain F

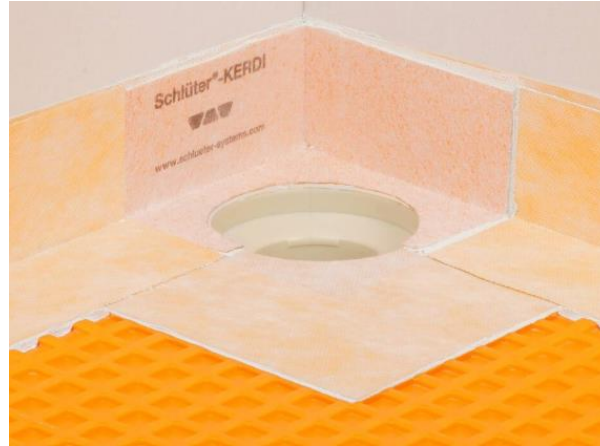

Kerdi Drain H

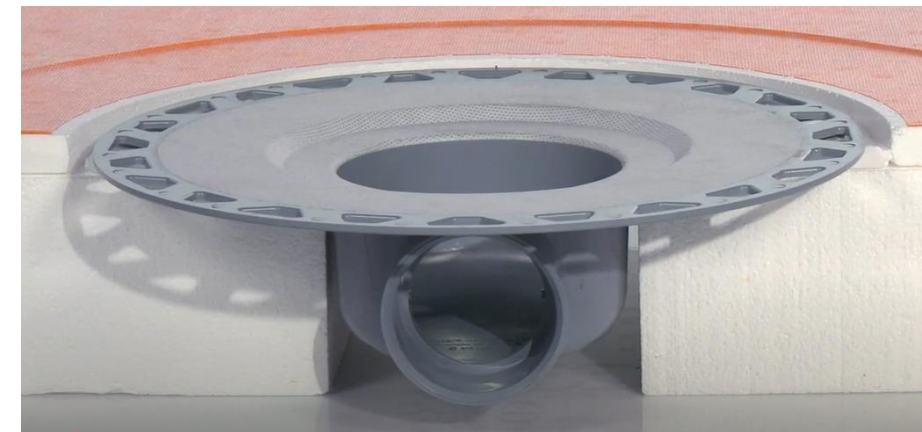

Tiled Niches & Shelves

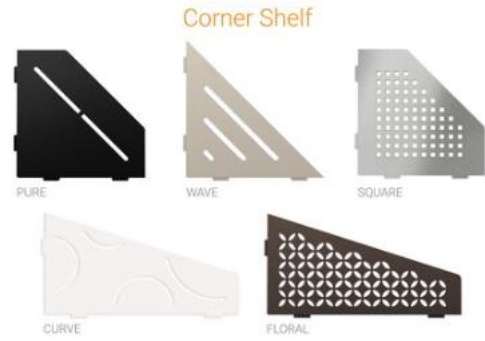

Schluter®-SHELFE

Niche Shelf

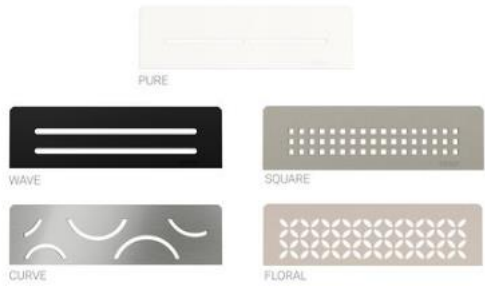

Schluter®-SHELFE-N

Wall Shelf

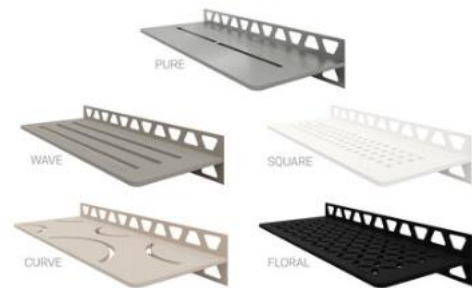

Schluter®-SHELFE-W

Shower niche with LIPROTEC LED lighting

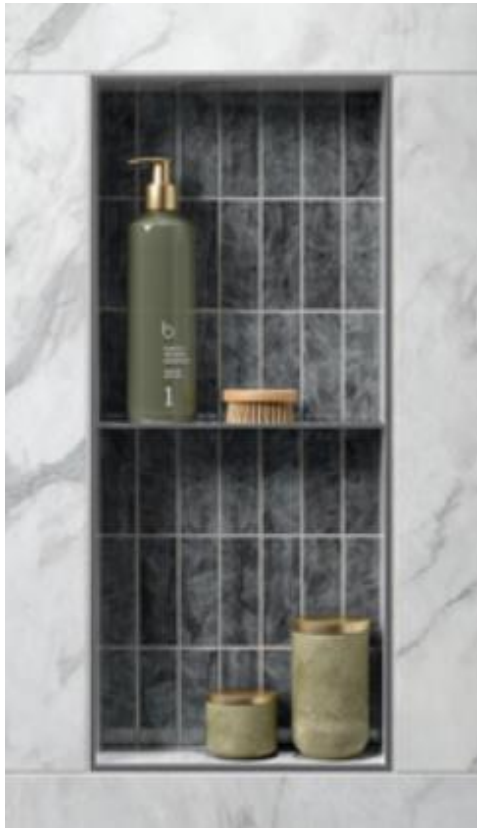

Design Niches- Powder Coat Niches

Color-coated aluminum

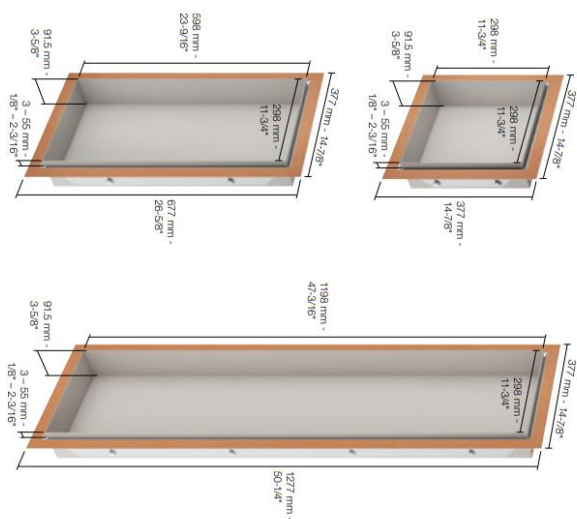

Floor membranes

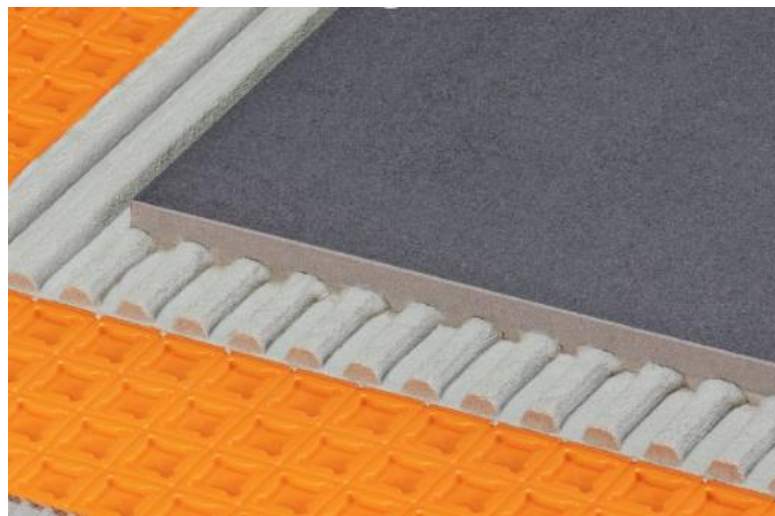
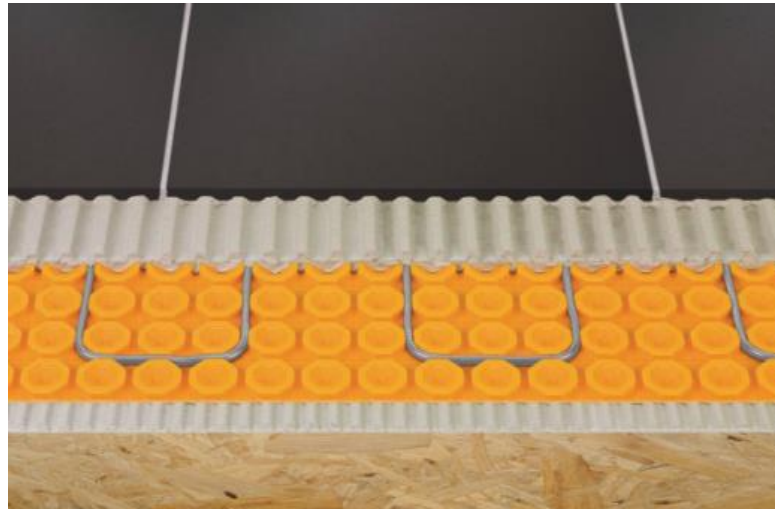
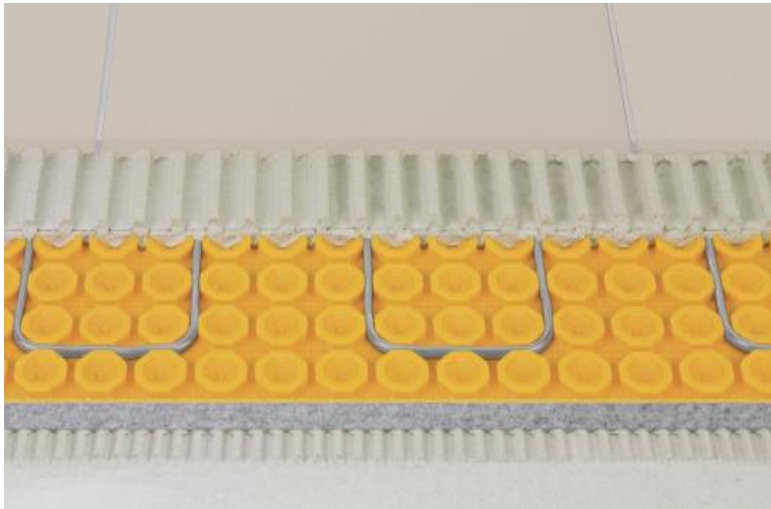

Heated Floors and Thermostats



Schluter@-DITRA-HEAT-E-RR
Thermostats
Power module for DITRA-HEAT-E-WIFI/-RT/-R thermostats



Schluter@-DITRA-HEAT-E-R
Thermostats
Non-programmable digital thermostat for the DITRA-HEAT system



Schluter@-DITRA-HEAT-E-RT
Thermostats
Programmable touchscreen thermostat for the DITRA-HEAT system



Schluter@-DITRA-HEAT-E-Wifi
Thermostats
Programmable Wi-Fi thermostat for the DITRA-HEAT system



Schluter@-DITRA-HEAT-E-RS1
Thermostats
Smart Thermostat for the DITRA-HEAT system



Schluter@-DITRA-HEAT-E-RRS
Thermostats
Power module for DITRA-HEAT-E-RS1 smart thermostat



6.4 Schluter®-DITRA-HEAT-E-HK

Heating Cable

Item No.	Heating Cable Length		Area Covered per Cable Spacing				Total Power (W)	Avg. Power per Unit Area per Cable Spacing				Current (Amps)
			Regular 3 Stud		Alternating 3-2 Stud			Regular 3 Stud		Alternating 3-2 Stud		
	(ft)	(m)	(ft²)	(m²)	(ft²)	(m²)		(Watts/ft²)	(Watts/m²)	(Watts/ft²)	(Watts/m²)	
Heating Cable (120 V)												
DHE HK 120 11	35.3	10.8	10.7	1.0	8.9	0.8	135	12.6	136	15.2	164	1.1
DHE HK 120 16	52.9	16.1	16.0	1.5	13.3	1.2	203	12.7	136	15.2	164	1.7
DHE HK 120 21	70.5	21.5	21.3	2.0	17.8	1.7	270	12.7	136	15.2	164	2.3
DHE HK 120 27	88.2	26.9	26.7	2.5	22.2	2.1	338	12.7	136	15.2	164	2.8
DHE HK 120 32	106.8	32.2	32.0	3.0	26.7	2.5	405	12.7	136	15.2	164	3.4
DHE HK 120 38	124.1	37.8	37.5	3.5	31.3	2.9	475	12.7	136	15.2	164	4.0
DHE HK 120 43	141.1	43.0	42.7	4.0	35.6	3.3	540	12.7	136	15.2	164	4.5
DHE HK 120 51	169.8	51.8	51.4	4.8	42.8	4.0	650	12.7	136	15.2	164	5.4
DHE HK 120 64	212.9	64.9	64.4	6.0	53.7	5.0	815	12.7	136	15.2	164	6.8
DHE HK 120 73	240.2	73.2	72.7	6.8	60.6	5.6	920	12.7	136	15.2	164	7.7
DHE HK 120 83	275.5	84.0	83.3	7.7	69.4	6.5	1055	12.7	136	15.2	164	8.8
DHE HK 120 92	303.0	92.4	91.7	8.5	76.4	7.1	1160	12.7	136	15.2	164	9.7
DHE HK 120 102	336.9	102.7	101.9	9.5	84.9	7.9	1290	12.7	136	15.2	164	10.7
DHE HK 120 113	372.2	113.4	112.6	10.5	93.8	8.7	1425	12.7	136	15.2	164	11.9
DHE HK 120 134	444.0	135.3	134.3	12.5	111.9	10.4	1700	12.7	136	15.2	164	14.2
Heating Cable (240 V)												
DHE HK 240 11	35.3	10.8	10.7	1.0	8.9	0.8	135	12.6	136	15.2	164	0.6
DHE HK 240 16	53.1	16.2	16.1	1.5	13.4	1.2	203	12.6	136	15.2	164	0.8
DHE HK 240 21	70.6	21.5	21.4	2.0	17.8	1.7	270	12.7	136	15.2	164	1.1
DHE HK 240 27	88.2	26.9	26.7	2.5	22.2	2.1	338	12.7	136	15.2	164	1.4
DHE HK 240 32	105.8	32.2	32.0	3.0	26.7	2.5	405	12.7	136	15.2	164	1.7
DHE HK 240 38	124.1	37.8	37.5	3.5	31.3	2.9	475	12.7	136	15.2	164	2.0
DHE HK 240 43	141.0	43.0	42.6	4.0	35.5	3.3	540	12.7	136	15.2	164	2.3
DHE HK 240 53	176.3	53.7	53.3	5.0	44.4	4.1	675	12.7	136	15.2	164	2.8
DHE HK 240 64	211.6	64.5	64.0	5.9	53.3	5.0	810	12.7	136	15.2	164	3.4
DHE HK 240 75	248.2	75.7	75.1	7.0	62.6	5.8	950	12.7	136	15.2	164	4.0
DHE HK 240 85	282.1	86.0	85.3	7.9	71.1	6.6	1080	12.7	136	15.2	164	4.5
DHE HK 240 103	339.4	103.4	102.7	9.5	85.6	7.9	1300	12.7	136	15.2	164	5.4
DHE HK 240 129	425.8	129.8	128.8	12.0	107.3	10.0	1630	12.7	136	15.2	164	6.8
DHE HK 240 145	480.5	146.5	145.3	13.5	121.1	11.3	1840	12.7	136	15.2	164	7.7
DHE HK 240 167	551.0	167.9	166.7	15.5	138.9	12.9	2110	12.7	136	15.2	164	8.8
DHE HK 240 183	605.9	184.7	183.3	17.0	152.7	14.2	2320	12.7	136	15.2	164	9.7
DHE HK 240 204	673.8	205.4	203.8	18.9	169.9	15.8	2580	12.7	136	15.2	164	10.7
DHE HK 240 225	744.4	226.9	225.2	20.9	187.7	17.4	2850	12.7	136	15.2	164	11.9

Profiles



For Floors

For Walls

For Countertops

For Stairs



Cove-shaped Profiles

Movement Joint Profiles



Profiles for LVT

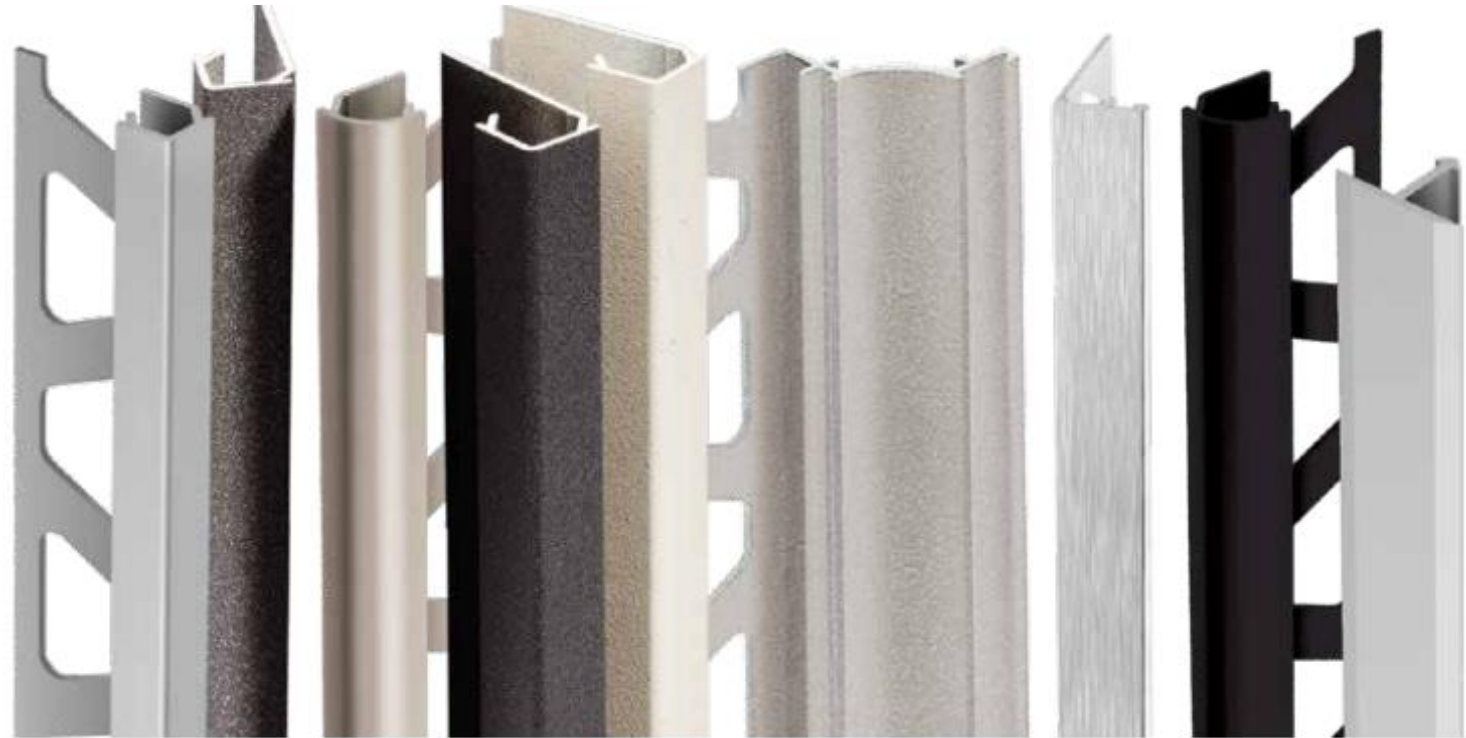

Choosing The Correct Profile Thickness

When Schluter first produced profiles, tiles were smaller, and you could match our profile to the tile thickness with no issue.

As tile has trended towards larger dimensions, thicker mortar beds were required for proper bond.

**What constitutes Large Format?
Any tile with a dimension equal to or greater than 15".**

Our 110 sizes were introduced to accommodate the most common tile thickness (3/8") in a large format application. The additional thickness of mortar would lead to a flush transition to the 110 size (7/16").



Match Profiles To Tile- Not Fixtures



Schluter®-SCHIENE



Schluter®-JOLLY



Schluter®-RONDEC



Schluter®-QUADEC



Schluter®-FINEC

***Color Codes**

TSI	TSBG	TSSG	TSC	TSB	TSR	TSOB	TSG	TSLA	TSDA
Ivory	Greige	Stone grey	Cream	Beige	Rustic brown	Bronze	Pewter	Light anthracite	Dark anthracite

***Color Codes**

MBW	MGS
Matte white	Matte black



Schluter®-DILEX-BWS



Schluter®-DILEX-AHK



Schluter®-SHELF



Schluter®-DECO-SG



Schluter®-KERDI-LINE-VARIO



Schluter®-KERDI-DRAIN/-A/-H

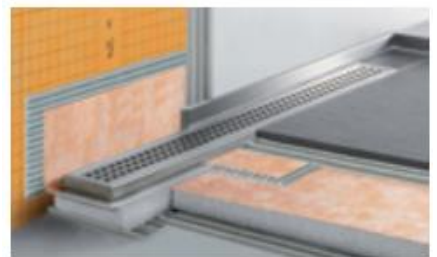

Schluter®-KERDI-LINE